



KRENDL™

The Innovator in Insulation Equipment



OWNERS MANUAL

MODEL #2800-G



60 YEARS OF AMERICAN INGENUITY

KRENDL MACHINE COMPANY • 1201 SPENCERVILLE RD
DELPHOS, OHIO 45833 • TELEPHONE 800-459-2069 • FAX 419-695-9301
E - MAIL: krendl@krendlmachine.com • WEB SITE: www.krendlmachine.com

CONGRATULATIONS ON YOUR PURCHASE OF KRENDL EQUIPMENT

**MODEL #2800-G
OWNER'S MANUAL**

FOR ASSURED SAFETY AND CONFIDENCE, PLEASE READ THIS MANUAL CAREFULLY BEFORE INSTALLING AND OPERATING YOUR MACHINE.

WARNING: FOR ANY GAS OR DIESEL EQUIPMENT THAT IS NOT INSTALLED IN A TRUCK OR TRAILER BY KRENDL MACHINE, **WARRANTY WILL BE VOIDED IF NOT INSTALLED TO THE EXACT INSTRUCTIONS OF THIS MANUAL. (SEE INSTALLATION SECTION)**

**E-MAIL ADDRESS IS: krendl@krendlmachine.com
WEB SITE IS: www.krendlmachine.com**

Table of Contents

	PAGE
INTRODUCTION.	1
UNPACKING & INSPECTING EQUIPMENT	2
GENERAL SAFETY INFORMATION.	2-4
DECALS	5-6
WARRANTY.	7
RETURNED GOODS PROCEDURE	8
SPECIFICATIONS	8
ASSEMBLY.	9
INSTALLATION	10-11
BASIC COMPONENTS.	12
OPERATING INSTRUCTIONS	
Machine Start-up.	13
Electrical Operation.	14-15
Machine Shut Down	15
Mechanical Settings.	16-17
GENERAL MAINTENANCE.	18-22
ELECTRICAL SYSTEM.	23-25
LADDER DIAGRAMS	26
TROUBLESHOOTING	27-28
SPARE PARTS LIST	28
PARTS LIST.	29-35
GLOSSARY.	36
SERVICE RECORD.	37

INTRODUCTION

Thank you for purchasing a **KRENDL INSULATION MOVING MACHINE**. With over sixty years experience in manufacturing insulation moving equipment, we have designed and built your machine with the highest quality to provide years of reliable service.

This manual has been prepared to help you obtain the maximum efficiency and service from your Krendl equipment. The machine is designed to condition and apply insulation with the utmost in dependable performance. Our primary objective is to build equipment which will provide complete satisfaction so that you may confidently recommend Krendl to others.

We do not manufacture or sell insulation. Our interest lies only in the proper performance of the equipment we manufacture. We make no recommendations or guarantees concerning various insulations.

CAUTION:

 This manual contains important information regarding the **safe** assembly and operation of your machine. We urge you to read it carefully and follow the instructions provided. If your questions are not answered in this manual, may we hear from you? We want you to be able to operate this unit safely and confidently.

UNPACKING: Store and unpack carton with correct side up. Unpack your machine **IMMEDIATELY** and check for damage in shipping. **Place any damage claim with delivering carrier, saving all packing materials for inspection.** Our warranty covers manufacturer's defects only. **DO NOT** return to shipper.

FILL IN AND RETAIN:

Krendl Machine Company
1201 Spencerville Rd
Delphos, Ohio 45833 U.S.A.

Telephone: 800-459-2069
Fax: 419-695-9301
E-mail: krendl@krendlmachine.com
Web Site: www.krendlmachine.com

For your protection in the event of theft or loss, please fill in the information requested for your own records. This information will be needed for in-warranty repairs. You may also want to attach a copy of your invoice.

Machine Model No. _____ Engine Manufacturer _____
Machine Serial No. _____ Engine Model No., Serial No. _____

Blower Manufacturer _____ Blower Clutch Manufacturer _____
Blower Model No., Serial No. _____ Blower Clutch Model No., Serial No. _____

Airlock Clutch Manufacturer _____ Date of purchase _____
Airlock Clutch Model No., Serial No. _____ Supplier _____

The model and machine serial numbers are located on the hopper of the machine unit. The blower(s) serial number(s) is located on the motor housing of the blower(s). The motor(s) serial number(s) is located on the motor(s) housing and the reducer serial number is located on top of the reducer.

UNPACKING AND INSPECTING EQUIPMENT

RECEIVING YOUR MODEL #2800-G KRENDL MACHINE:

Immediately check the condition of your Model #2800-G machine when it is received. It should be received in the same condition that it was shipped to you. **If there are any visible problems with your machine or any other items in the shipment, it is imperative that you place any claim with the delivery carrier.** Please save all packaging materials for inspection. The delivery carrier should also contact our office before leaving the premises to notify us of a claim. The ownership to your machine and all other items in the shipment were transferred to your name as soon as the shipment left our premises, thus it is your responsibility to contact us with any claims. Contact the truck line to arrange for an independent inspector to come out to inspect the damage and to prepare the inspection report. It is imperative that this inspection is done prior to unpacking or using any of the equipment. Please contact us for assistance or with any questions you may have regarding the claim process.



UNPACKING:

Handle all cartons with care to avoid damage from dropping or bumping. Completely remove machine from the packaging and from any shipping pallet or skid to which it might be attached. In addition, completely remove all shipping materials from inside the machine. Check that all parts are included as stated on the below.

ACCESSORIES INCLUDED:

- 150' REMOTE CONTROL CORD
- SPANNER WRENCH FOR BELT TENSIONERS
- 5/16 ALLEN WRENCH FOR ADJUSTMENT OF CHAIN IDLERS
- MULTIMETER
- #50 CHAIN MASTER LINK
- EXHAUST SYSTEM
- OWNERS MANUAL

GENERAL SAFETY INFORMATION

-  **Important:** Read **all** instructions **before** operating this unit. This equipment can be potentially dangerous and must be used in strict accordance with instructions.
-  **Disclaimer Notice:** The manufacturer will not be legally responsible for any injury or damage resulting from the improper use of this equipment or the failure to follow instructions.
-  **Important:** Please recheck inside the hopper for any loose items or damaged equipment. Injury may occur when equipment is started with foreign material in the hopper.



General Safety

1. Read this manual carefully and become familiar with your machine. It is important to know its applications, limitations, and any hazards involved prior to operating the machine.
2. This machine was designed and manufactured for blowing cellulose, fiberglass and mineral fiber. Do not attempt to modify the unit or use it for any application it was not designed for. If you have any questions about your intended use or the machine's suitability, ask your dealer/distributor or consult the factory. The manufacturers could not possibly anticipate every circumstance that might involve a hazard. For that reason, warnings in the manual and warning tags or decals affixed to the unit, are not all-inclusive. If you intend to handle, operate, or service the unit by a procedure or a method not specifically recommended by the manufacturer, first make sure that such a procedure or method will not render this equipment unsafe or pose a threat to you and others.
3. Do not disable any of the safety features on the equipment. These features are for your protection and safety.
4. Read and obey all safety and operating instructions in the manual and on the machine.
5. Equipment is to be operated and/or maintained by TRAINED & QUALIFIED personnel ONLY!!
6. **BEFORE PERFORMING ANY MAINTENANCE ON THE MACHINE, YOU MUST FIRST:**
#1 TURN MAIN SWITCH LOCATED ON MACHINE TO THE "OFF" POSITION
#2 TURN THE ENGINES IGNITION TO THE "OFF" POSITION AND REMOVE KEY
#3 DISCONNECT THE BATTERY CABLE
7. Do not operate the machine without all guards and safety equipment installed in the proper location and in working order. Always follow the proper shut down procedures outlined in Item 6 when guards are removed from the machine or when compartment or electrical control doors need to be opened.
8. If a malfunction occurs while running the machine, turn it off immediately, follow the directions under item 6 and correct the problem prior to restarting the machine.
9. Keep body and all clothing away from rotating equipment. Rotating shafts can be dangerous.
10. Always wear proper safety equipment when operating the machine. This includes steel toed shoes, safety glasses and a respirator.
11. Under no circumstances should your hand, a stick or a broom be used to force material down into the hopper. The machine is a self feeding design and requires no outside assistance.
12. Stand on the floor, not a platform while operating the machine. The operator may lose balance and fall while loading bags of material.



Electrical Safety

- The **National Electric Code (NEC)** in the United States and many international electrical codes require frame and external electrically conductive parts of this machine to be properly connected to an approved earth ground. Local electrical codes may also require proper grounding of machine. Consult with local electricians for grounding requirements in your area.
- Never handle any kind of electrical cord or device while standing in water, while barefoot or while hands or feet are wet. Dangerous electrical shock will result.
- Use a ground fault circuit interrupter (GFCI) in any damp or highly conductive area. (metal decking or steel work)
- Reference NFPA 79, 70E, or OSHA safe work practices when performing energized work procedures.



Safety/Caution

- **Be Safe** - Keep away from moving parts.
- **Be Safe** - Make sure all guards and hopper extensions are in proper place **before** operating machine. Guards and safety devices/switches should not be removed, modified or by-passed. Hands should **never** pass between rotating parts.
- **Be Safe** - Remove key from ignition and disconnect red positive battery cable **before** removing motors or hopper.
- **Be Safe** - Maintenance service must be performed by a qualified technician.
- **Be Safe** - Remove key from ignition and disconnect red positive battery cable **before** inspecting or adjusting unit.
- **Be Safe** - Consult a qualified technician to answer questions **before** attempting to operate, or injury may result.
- **Be Safe** - Do not operate machine alone.
- **Be Safe** - Do not leave machine unattended and energized.
- **Be Safe** - Turn ignition off and disconnect red positive battery cable **before** clearing and feeding jam or attempting to remove any object dropped in the hopper.
- **Be Safe** - Keep hands, loose clothing, jewelry and hair away from agitators, gears, chains and other moving parts.
- **Be Safe** - Use proper lifting when moving insulation and loading machine.
- **Be Safe** - Keep work area clear of debris.
- **Be Safe** - Wear proper safety equipment, including protective gear, such as respirators, eye and ear protection.
- **Be Safe** - Violation of the Owner's Manual or safety precautions may void warranty.



Make Sure!

- Hopper is empty of foreign objects **before** starting.
- Blower filter is kept clean and in place when blower is on.
- Machine is turned off **immediately** if hose is plugged, or blower will overheat.
- Machine must be on **before** adding insulation.
- Blower must be on, when agitators are running, or machine will bind.
- Agitator motor should not be run with hopper empty for more than a few minutes, or damage to seals will result.
- Sprockets, chains, belts and pulleys are correctly **aligned** and **tensioned**.
- Pieces of bag are **not** left in the machine as this can bind and stall your machine.
- This machine should only be used with good quality insulations that are dry, undamaged and that meet a certain industry specification or quality standards.

DECALS



Keeping the filter clean will result in longer blower life and better performances.



Rotating parts can be dangerous! You can snag clothes, hair, hands, etc. This can cause serious injury or death.



Rotating parts move in this direction.



Indicates which way opens and closes the material feed gate which in turn controls the production



Made in the U.S.A.



Part number for identification and tracking.



Indicates location of the fuel shut-off valve.

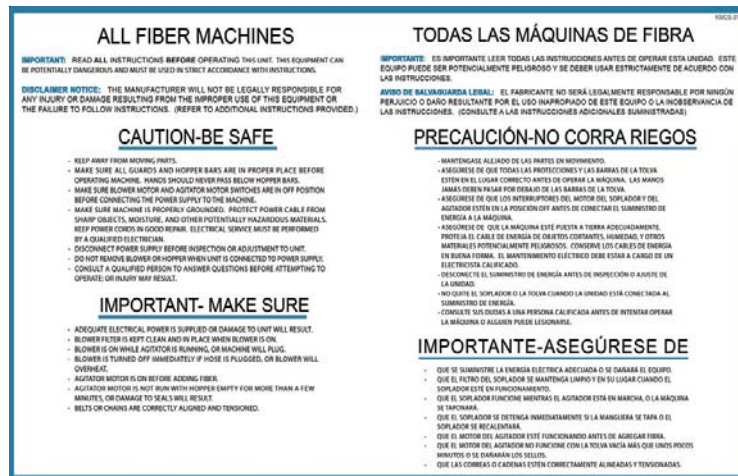

General safety information intended to reduce the risk of serious injury or death

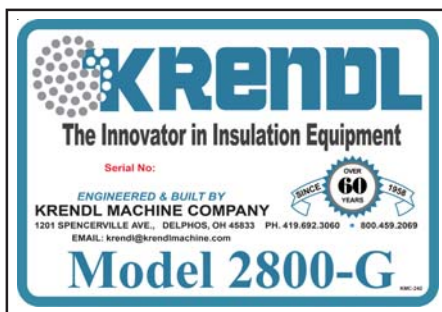

Manufacturer information is provided here along with machine serial number.

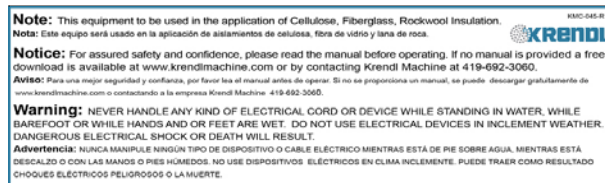

Identifies what type of insulation should be used with this machine and that the manual should be read before operating. Warns to be careful around electrical components! This can cause serious injury or death.



Identifies position of material feed gate.



Indicates that the Air Inlet must have unrestricted air flow at all times to prevent over heating of engine compartment.



Indicates which employee inspected equipment and on what date.



Indicates that Krendl Machine Company is in compliance with EPA codes.



Indicates this part of the machine is not a step.



During operation, this machine is loud. Wear hearing protection. Failure to do this could result in hearing loss.



Indicates the controls that start, stop, and run the machine.



Provides the necessary instructions to properly operate and troubleshoot the machine. Failure to follow these instructions could result in damage to the machine.



Indicates if blower is off, on, or on with agitator.



Indicates the controls that operate the engine and control the air flow.



Identifies air adjustment control.



Indicates that the electrical box on the machine is in compliance with UL codes.



Do not smoke around machine. Machine contains a flammable liquid. Failure to do this could cause serious injury or death.



Indicates that the engine requires fresh air. Supplying the engine with fresh air will result in better performance and longer life.

WARRANTY:

Krendl Machine Company (Company) warrants to each original purchaser (Buyer) of its machines that such products will be free of manufacturing defects for a period of 2 years from the date of shipment to the Buyer. (This does not include accessories, pumps, blowers, wall scrubbers, etc.)

Warning: For any gas or diesel equipment that is not installed in a truck or trailer by Krendl Machine, warranty will be voided if not installed to the exact instructions of this manual. (See installation section).

No warranty is made with respect to:

1. Components or accessories manufactured and warranted by others. Warranties for purchased component parts as supplied from vendor such as engine, electric motor, blower, gearbox, transmission, etc., if furnished by the manufacturer of the component, are on file at the Company's main office and copies will be furnished at request of Buyer. Component(s), shipping costs prepaid, shall be sent to Company who in turn shall forward to vendor for evaluation and warranty determination.
2. Any defect caused by repair, alteration and/or adjustment performed by Buyer or customer/vendor of Buyer without the express written authorization of the Company.
3. The labor costs of replacing parts by parties other than the Company.
4. Any machine that has not been operated and/or maintained in accordance with normal industry practice and the written recommendations of the Company. (e.g. machine operated with an improperly sized, worn or damaged hose, improper or inattention to preventative maintenance, etc.)
5. The product has been subjected to misuse, negligence or accident or results of any application or use of the blowing equipment not in accordance with the Company recommendations.

This limited warranty does not cover the free replacement of component parts that become inoperative due to wear and usage and need to be replaced on a regular basis, including but not limited to: airlock seal(s), agitator(s), shredder(s), auger(s), fuse(s), switch(es), clutch(es), hose(s), shaft seal(s), chain(s), belt(s), sprocket(s), pulley(s), bearing(s), cable(s), battery(ies), filter(s), fan(s), etc.

The Company's obligation under this warranty is limited to repairing or replacing (at Company option) any part that is determined by the Company to be suffering from a manufacturing defect. The Company (at Company option) will provide any required parts and labor to the Buyer. If the equipment or parts must be returned to the Company for repair, all transportation costs shall be the Buyer's responsibility.

THIS LIMITED WARRANTY IS EXPRESSLY IN LIEU OF ANY OTHER GUARANTEES AND / OR WARRANTIES, ORAL OR WRITTEN, EXPRESSED OR IMPLIED, INCLUDING WITHOUT LIMITATION, THE IMPLIED WARRANTY OF MERCHANTABILITY. NO WARRANTY, EXPRESS OR IMPLIED, OTHER THAN THE AFORESAID WARRANTY IS MADE OR AUTHORIZED BY COMPANY. COMPANY SHALL NOT BE LIABLE FOR ANY DIRECT, INDIRECT, INCIDENTAL OR CONSEQUENTIAL DAMAGES TO PROPERTY OR INJURY TO ANY PERSON OR COSTS ASSOCIATED WITH LOSS OF PRODUCTION RESULTING IN LOSS OF REVENUE, PROFITS OR LOSS OF EQUIPMENT THROUGH THE USE OF THIS EQUIPMENT.

Note: Special job circumstances incurring costs for specialized repair and next day delivery of parts will not be reimbursed by the manufacturer unless authorized by factory.

RETURNED GOODS PROCEDURE:

IF MACHINE WAS NOT PURCHASED DIRECTLY FROM KRENDL MACHINE COMPANY, CONTACT YOUR SUPPLIER / DISTRIBUTOR.

When returning products to Krendl for repair, first obtain a return goods authorization, at which time you will be given shipping instructions. The product must be shipped **PREPAID**:

Krendl Machine Company
1201 Spencerville Rd
Delphos, Ohio 45833 U.S.A.

Telephone: 800-459-2069
Fax: 419-695-9301
E-mail: krendl@krendlmachine.com
Web Site: www.krendlmachine.com

Once the unit is received, it will be inspected. In-warranty units will be repaired and returned immediately. An estimate of repair charges will be provided for out-of-warranty units.

SPECIFICATIONS

MODEL #:	2800-G
AIRLOCK DIAMETER:	12" (30.4 cm)
AIRLOCK LENGTH:	16" (40.6 cm)
OVERALL HEIGHT:	73" (185.4 cm)
LOAD HEIGHT:	56 1/2" (143.5 cm)
WIDTH (Depth):	41" (99 cm)
LENGTH:	65" (174 cm)
WEIGHT (Pounds):	1195 (542 kg)
ELECTRICAL:	12VDC control system
BLOWER VOLUME (cfm):	135
BLOWER PRESSURE (psi):	6.0 Maximum
AIRLOCK OUTPUT (Diameter):	4" (10.2 cm)
MAXIMUM FEED RATES:	
Cellulose:	4100 lbs./hr. (1859 kg./hr.) 137 bags per hour
Fiberglass:	2100 lbs./hr. (953 kg./hr.) 70 bags per hour

WARNING: Recommended hose size, type and length must be used to achieve maximum results. Krendl cannot guarantee performance of the machine if hoses are under-sized, worn, damaged, or hoses other than those we recommend are used.

BEFORE YOU RUN THIS MACHINE...PLEASE READ THE REST OF THIS MANUAL!!

ASSEMBLY

Prior to packing, your machine has been assembled and tested to assure quality performance. However, to safeguard against damage in shipping, certain items are packaged separately within your carton and will need assembly.

BLOWER AIR INLET SYSTEM: (See Illustration A)

Prior to packing, the blower filter and blower air inlet manifold were placed inside the machines hopper to safeguard against damage in shipping. Remove blower air inlet system and install.

EXHAUST SYSTEM:

Prior to packing, the flexible exhaust piping, muffler, exhaust brackets and clamps were placed inside the machines hopper to safeguard against damage in shipping. Remove exhaust system and install.

SLIDEGATE HANDLE:

Prior to packing, the slidegate handle was assembled backwards to safeguard against damage in shipping. Remove handle and reinstall, so handle sticks out back of machine. **Do not** over tighten nut, so handle is free to spin.

ASSEMBLY OF OPTIONS: (See illustration A)

Bushing Reducer: (3" output)

Bushing reducer inserts into output tube of airlock. Press reducer firmly against shoulder and tighten two hold-down bolts to secure unit in place. The bushing reduces the size of opening at the airlock to match the hose, providing a more consistent feed while preventing plugged hoses. (Standard output tube on model #2800-G is 4".)

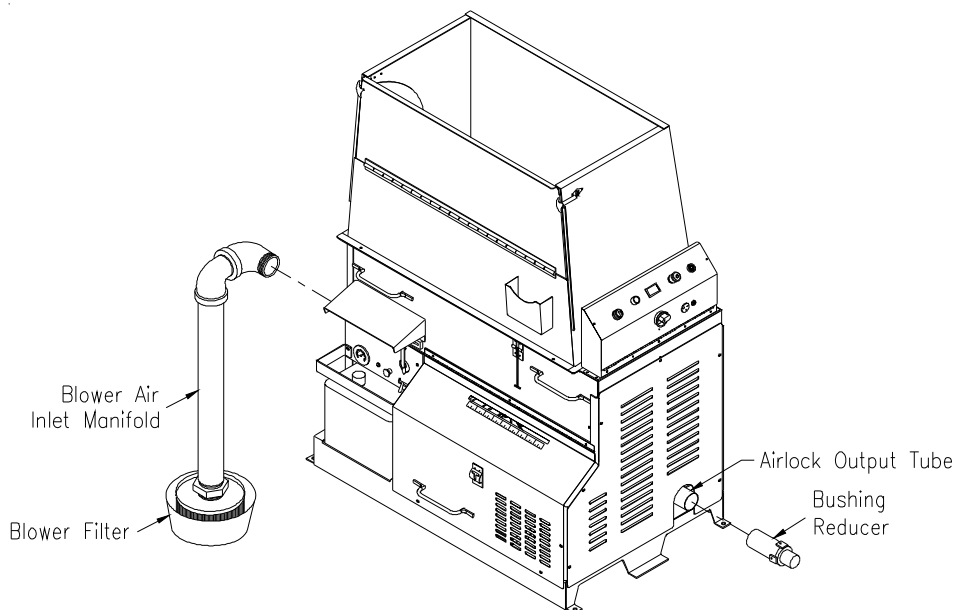

(Illustration A)

INSTALLATION

MACHINE INSTALLATION SPECIFICATIONS:

Your Model #2800-G Krendl Machine can be mounted in any truck, trailer or chassis configuration. The body should have a full width rear door. The Krendl Model #2800-G Machine can be mounted anywhere in the truck body, as long as the engine, blower and electric cooling fan can receive fresh air.

*****INSTALLATION NOTE: It is very important that all of the truck or trailer body doors be open to provide proper ventilation to the engine. If the unit cannot receive clean cool air, engine cooling problems may occur. This will void the warranty on the machine and the engine!**

TOOLS NEEDED:

- 1/2" Heavy Duty Drill
- Drill Bits: 9/16" for bolts
- Fork Lift (means to lift the machine)
- Pry Bars
- Basic Wrenches
- 2" & 4" Hole Saw
- Sawzall

INSTALLATION INSTRUCTIONS:

- 1) Position the machine in the truck or trailer so that the engine, blower and cooling fan can get fresh air.
- 2) Check under the truck or trailer body that the air inlet, engine exhaust, fresh air flange, blower air inlet and machine mounting holes will not interfere with any components underneath. If there is an interference with any of the components, then you will need to adjust the position of the machine to clear the obstruction. **Note: It is the manufacturers recommendation that the blower filter be mounted under the truck.**
- 3) Mark location of machine and remove so holes can be located and cutout.
- 4) Cut the following holes: **(Use illustration B as a reference ONLY)**
 - a. Air Inlet
 - b. Engine Exhaust
 - c. Fresh Air Flange
 - d. Blower Air Inlet

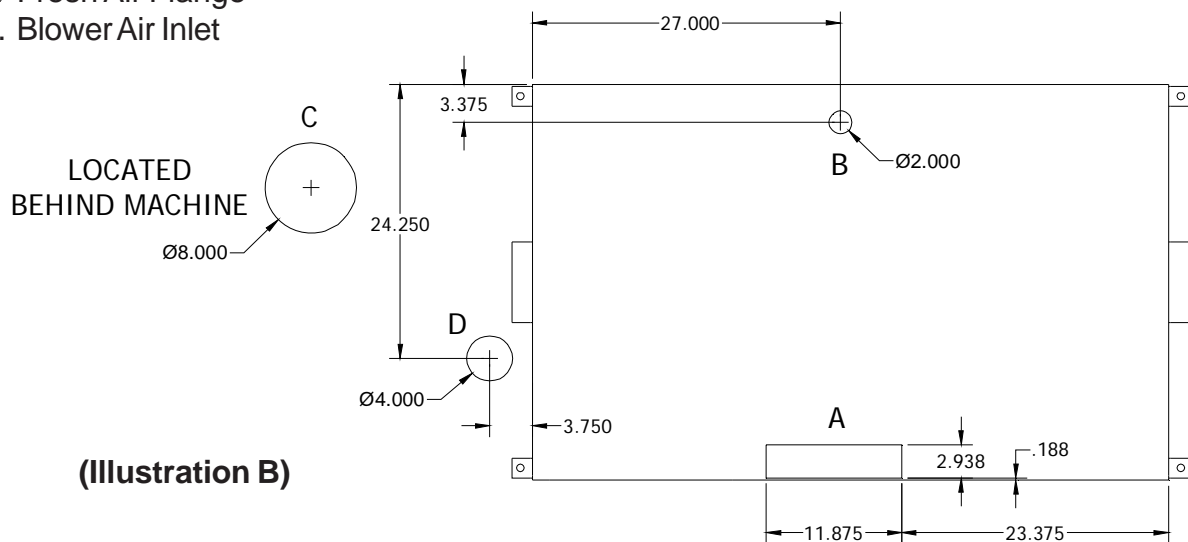

(Illustration B)

- 5) Place the machine in the truck or trailer and line it up with the holes.
- 6) Slide the air inlet into position from underneath the truck or trailer and secure with screws (hardware provided). **Note: Air inlet should slide inside the engine shroud if installed correctly.**
- 7) Drill 9/16" holes on all four corners of the base using the machine hold downs as guides.
- 8) Fasten machine down on all four corners using 1/2" bolts, washers, lock washers and nuts. (See illustration C) **Note: Hardware is not included and length of bolts may vary due to thickness of floor.**
- 9) Run exhaust out of the truck or trailer using the supplied flexible exhaust (See illustration C) **Note: Make sure the exhaust is routed away from the blower and engine air intake.**
- 10) Attach muffler to flexible exhaust and mount underneath truck or trailer using supplied mounting bracket. (See Illustration C) **Note: Secure mounting bracket with two 5/16" lag bolts.**
- 11) Attach the supplied 8" hose to the back guard and fresh air flange. Secure with hose clamps. Do not cover the air inlet with any type of panel that may restrict airflow (louvered panel, expanded metal, mesh screen, filter, etc.). It is imperative that the cooling fan has the necessary volume of air to keep the engine and other components from overheating.

WARNING: Engines give off carbon monoxide, an odorless, colorless, poison gas. Breathing carbon monoxide can cause nausea, fainting or death. Do not start or run engine when exhaust is not properly ran outside.

WARNING: For any gas or diesel equipment that is not installed in a truck or trailer by Krendl Machine, warranty will be voided if not installed to the exact instructions of this manual. (See installation section).

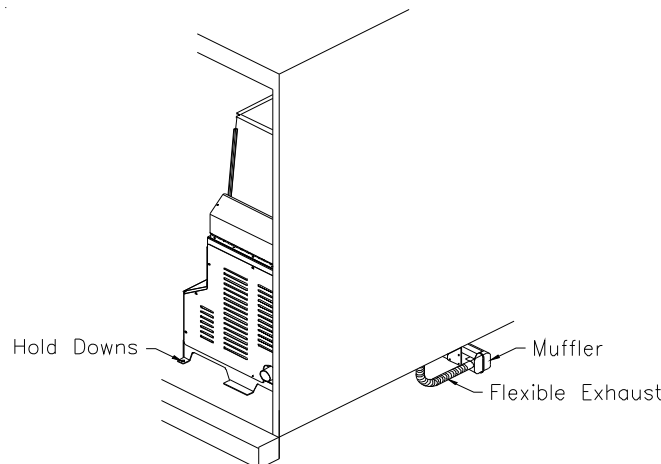

(Illustration C)

BASIC COMPONENTS

This is a view of the basic components of your machine. It shows the location of each item and gives the function of each. Use this as a guide throughout the manual.

- A) BASE UNIT** — Lower frame unit supporting blower, speed reducer, motor, airlock and hopper.
- B) AIRLOCK** — Traps air and insulation while providing a metered flow.
- C) SLIDEGATE** — Meters the amount of insulation dropping into the airlock by controlling size of airlock opening.
- D) SPEED REDUCER** — Reduces speed of agitators/airlock drive motor while output power remains constant.
- E) BLOWER** — Provides the air necessary to move insulation from the airlock.
- F) MOTOR** — Provides driving power for speed reducer, blower and agitator/airlock system.
- G) AGITATOR** — Conditions and augers insulation in the hopper.
- H) HOPPER** — Upper unit of machine holding insulation which includes hinged access door.
- I) KILL SWITCH** — Safety device for immediate stopping of machine. (Located on electrical box)
- J) SHREDDER SYSTEM** — Increases production and coverage on all insulation products while reducing clumps that may exist in various insulations.
- K) MAIN CONTROL PANEL** — Connects with main power, allowing operation of unit at machine or Remote Cord.
- L) BATTERY** — Supplies power for the electric start on the engine.
- M) FUEL TANK** — Provides the fuel necessary to run the machine.
- N) HOUR METER / TACHOMETER** — Monitors the use and speed of the engine. (not shown)

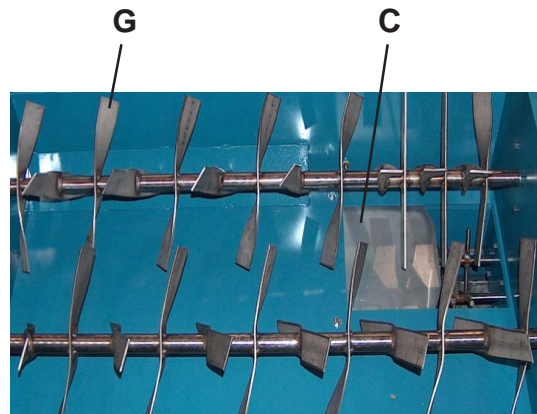
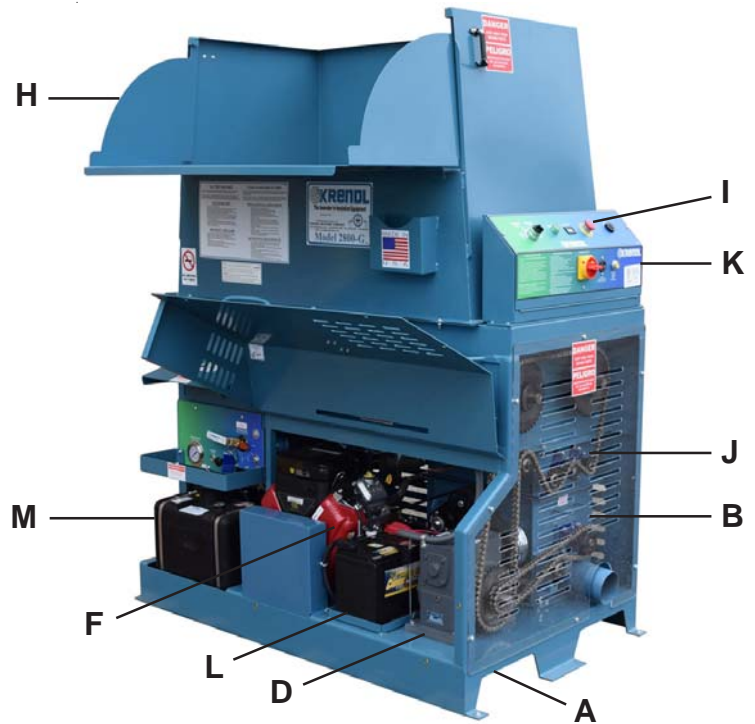

(Illustration D)

OPERATING INSTRUCTIONS**Machine Start-up**

This unit comes ready for connection to insulation hose and accessories.

Starting Your Krendl Model #2800-G Machine:

- 1) After installing your Model #2800-G according to the installation instructions, it is now time to start your machine. Again, check all engine fluid levels, belt tension, and that all guards are installed properly.
- 2) Slide hose on to airlock outlet and secure with a hose clamp. **Note: All hose connections must have hose clamps to prevent air leakage from blower to nozzle. This helps prevent hose plugging.**
- 3) Make sure the control switch on the remote control cord is in the "off" position. Now, you may plug in the remote control cord into **Main Control Panel Box** located on hopper. (See Illustration E)
- 4) Make sure fuel shut off valve is in the "on" (horizontal) position.
- 5) Pull choke out and start engine. Close choke after 3 seconds. Let engine warm up for a few minutes before setting throttle to "fast".
- 6) Make sure slidegate is closed.
- 7) Put insulation in hopper. **Note: The first bag of insulation into hopper should be well broken by hand to assist agitator action. Caution: Never put hands in hopper when machine is running or force feed fiber by pushing down on insulation.**
- 8) Your machine is now ready for operation.



(Illustration E)

Electrical Operation

PRESS KILL SWITCH TO IMMEDIATELY STOP MACHINE AT ANY TIME!

1. Make sure Kill Switch is out by pulling. (See Illustration F)
2. Turn *red* Main Disconnect Switch to ON position. (See Illustration F)
3. Set 4-Position Selector Switch to OFF. (See Illustration F)
4. Press *green* start Button. **Machine will not run unless start button is pressed *after* Kill Switch is out and *red* Main Disconnect Switch is on.** (See Illustration F)
5. Select operating mode on 4-Position Selector Switch from one of the following options:
Note: Engine must be running before an operating mode is selected.

- Remote:** Remote control hand pendant will control machine.
Off: Machine will not run. (overrides remote hand pendant)
Blower: Only the blower will run continuously. (manual control at machine)
Agitator-Feed/Blower: Both the blower and the agitator-feed will run continuously. (manual control at machine)

Main Control Panel (lid closed)

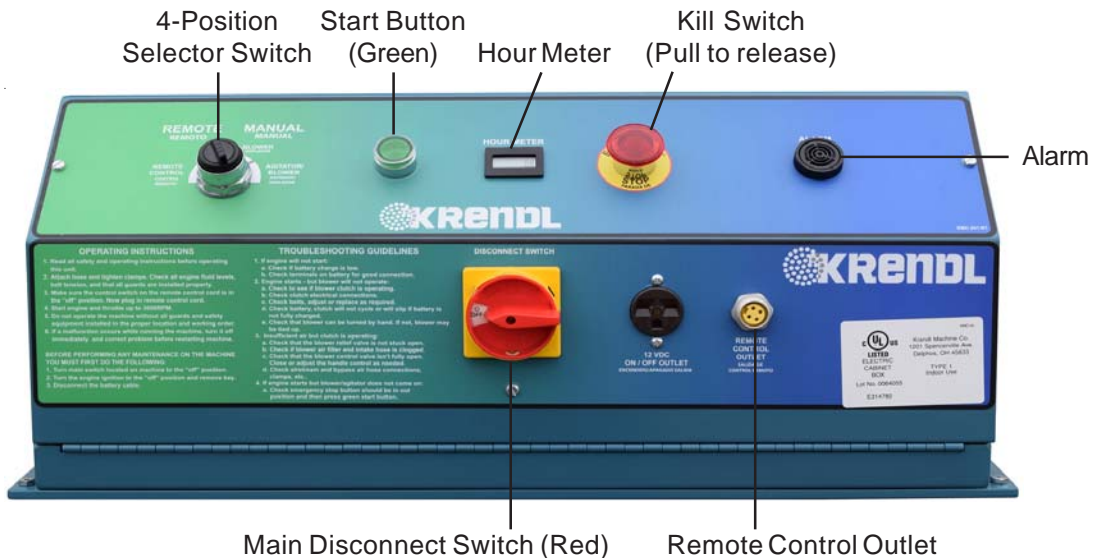

(Illustration F)

6. When operating in **Remote mode**, the 4-Position Selector Switch must be set to **Remote** position. (See Illustration F)
7. Remote control hand pendant positions will be selected from the following:

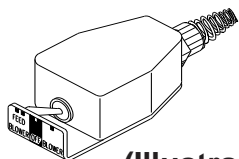

- BLOWER-FEED** - operates both **blower motor** and **agitator-feed motor** simultaneously
OFF - (middle position) all functions stop
BLOWER - operates the **blower motor** only

(Illustration G)

8. Use the 12 Volt DC Auxiliary Outlet on the Main Control Panel for supplying continuous power to Accessories.
9. Adjust blower(s) and slidegate to desired settings. (See page 16 and 17)

Electrical Operation Cont.

10. **To adjust alarm time**, for agitators and blowers follow the procedure below: (See Illustration H)
- Shut off machine and remove key from ignition.
 - Turn **off** *red* Main Disconnect Switch, loosen two screws in door, and open Main Control Panel lid.
 - Turn Timer Relay knob to desired setting. (clockwise to **increase** warning time)
 - Close lid, tighten two screws in door, turn machine on, turn on *red* Main Disconnect Switch and press *green* Start Button.
 - Retest machine.

Main Control Panel (lid open)

Timer Relay

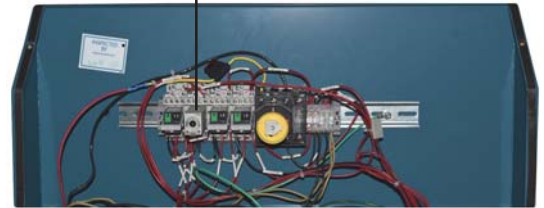

(Illustration H)

Machine Shut Down

Stopping Your Machine:

- Switch the remote switch to “BLOWER” and wait until the hose is clear of all material.
- Let the engine run for a couple of minutes to cool down.
- Turn the control switch on the remote control cord to the “off” position and unplug the remote control cord from the panel.
- Turn the key switch to the “off” position.



MACHINE DAMAGE NOTE:

DO NOT FILL THE HOPPER TO CAPACITY AT THE END OF THE DAY. THE MATERIAL WILL COMPRESS AND CAN CAUSE MACHINE LOCKUP DURING THE NEXT START-UP.

Mechanical Settings

Your machine contains blower and slidegate controls used to adjust your machine for each application and type of insulation. (See Illustration I for machine model and location of controls) **Blower control** (air) and **slidegate** (material feed) are adjusted according to:

- Application:** Open blow and spray-on applications require varying amounts of control.
- Type of Material:** Cellulose and fiberglass have different textures and densities that respond to machine settings.
- Hose:** Corrugations or roughness of interior surface, diameter, length and elevation of hose will also require varying adjustments.
- Weather Conditions:** Temperature and humidity may require day to day adjustment of machine settings.

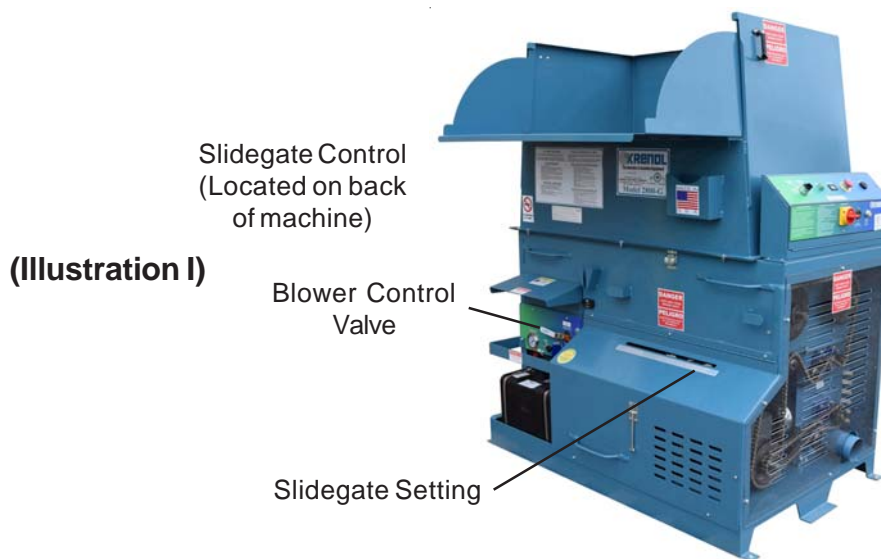

BLOWER CONTROL AND SLIDEGATE GENERAL SETTINGS:

Blower control can increase or decrease the amount of air in the system, affecting the velocity (speed) and spread rate (coverage) of insulation. (See Illustration I) The blower control valve is used for controlling air pressure and amount of air flow.

Opening or closing slidegate (material feed) controls the amount of insulation dropping into the airlock which changes the production rate (lbs. per hour). (See Illustration I) For calibration purposes the scale located on the machine indicates how many inches the airlock slidegate is opened.

The blower and slidegate controls **working together** affect the distance insulation can be blown through a hose without plugging. These controls also affect the accurate blowing of insulation for spraying applications.

These settings control the following:

- **Density** of insulation blown in retro-sidewall application.
- **Velocity** of material impact when spraying.
- **Dust** on open blow.
- Material **spread rate** or coverage.
- **Production** rate (lbs. per hour blown).

GENERAL BLOWER CONTROL AND SLIDEGATE SETTINGS FOR OPEN BLOW: (See Illustration I)
 With the **slidegate** closed and blower control valve on low (valve open), turn **agitator-feed and blower on**. Fill hopper with insulation and adjust **blower valve** and **slidegate**. In making adjustments, move controls proportional to each other. (i.e. If **blower valve** is half open, **slidegate** should be half open.) Open slidegate to allow insulation to drop into the airlock providing good production, but not beyond point where hose plugs. As hose length is increased, air pressure/volume is increased by closing off the **blower valve** while closing the slidegate proportionally. This will increase the distance insulation can be blown through the hose and improve material coverage rate, while decreasing the blowing production rate (lbs. per hour blown). These adjustments are for open blow. If specialty application or retro sidewall work is done, refer to General Blower/Slidegate Settings chart (below left) or insulation manufacturer.

GENERAL BLOWER/SLIDEGATE SETTINGS:

Since specific settings need to be determined by each operator, the following are only suggested guidelines. Consult the insulation manufacturer for additional recommendations specific to **their** product.

APPLICATION	BLOWER CONTROL	SLIDEGATE
Open Blow	3	Full Open
Wall Cavity Spray	1.5	Half Open

SHREDDER ASSEMBLY:

This unit is supplied with a shredder assembly; airlock/agitator speeds are preset at the factory. **No** further sprocket setting speeds are needed, as this system will accommodate most insulations and applications. However, the shredder **direction** can be adjusted as described below.

SHREDDER ADJUSTMENT:

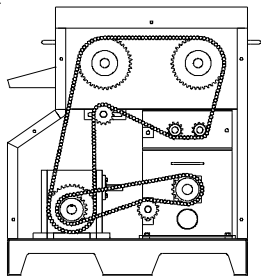

(Illustration J)

Unidirectional Rotation (See illustration J) is preferred as an all around setting for a combination of materials and applications. This setting provides for the greatest **coverage** and **best control** of the insulation in wall cavity spray, commercial spray, internal wetting (stabilized) and open blow applications.

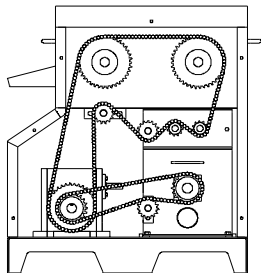

(Illustration K)

Center-Down Rotation (See illustration K) force feeds the insulation into the airlock at a faster rate. This direction is preferred for the greatest **production** of various insulations in an open attic blow application although coverage may decrease. This setting will provide ample coverage and good control of the insulation in wall cavity spray, commercial spray, internal wetting (stabilized) and open blow applications.

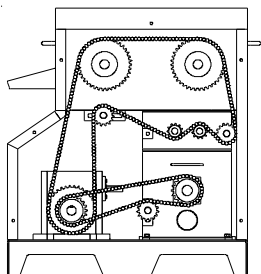

(Illustration K-1)

Center-Up Rotation (See illustration K-1) is preferred for extended **coverage** of various insulations. **Note: For this application an upgrade kit will be needed.**

GENERAL MAINTENANCE

Your Krendl Model #2800-G Machine is designed to be used with minimal maintenance for all its components. Periodic preventive maintenance will add years of life to your equipment. The following is only a guide; experience is the best guide for the right maintenance schedule for you.

DESCRIPTION	EACH SHIFT	40 HOURS	80 HOURS	200 HOURS	1000 HOURS
CHECK GUARDS	X				
CHECK ENGINE FLUID LEVELS	X				
CHECK DRIVE ALIGNMENT & TENSION		X			
CHECK ENGINE EXHAUST HOSE		X			
SERVICE ENGINE AIR CLEANER CARTRIDGE & CLEAN ENGINE COOLING SYSTEM		X			
VISUALLY INSPECT COUPLING ELEMENTS FOR FATIGUE CRACKS (OVER 1/2")		X			
CLEAN BLOWER AIR FILTER		X			
CHECK BLOWER OIL LEVEL		X			
CHANGE ENGINE OIL AND FILTER (See engine manufacturer's manual for recommended maintenance schedule of when oil and filter should be changed)					
GREASE BLOWER BEARINGS			X		
LUBRICATE DRIVE CHAINS WITH A DRY LUBRICANT				X	
GREASE SHREDDER, AIRLOCK, & AGITATOR BEARINGS				X	
CHANGE BLOWER OIL (needs to be changed after first 100 hours of operation and thereafter every 1000 hours)					X

NOTE: When further maintenance is needed, please refer back to other manufacturer's manuals for additional assistance!



SAFETY NOTE



WHEN MAINTENANCE IS TO BE PERFORMED ON THE MACHINE ALWAYS:

- 1) STOP THE ENGINE COMPLETELY.
- 2) TURN THE IGNITION TO THE "OFF" POSITION AND REMOVE THE KEY.
- 3) DISCONNECT RED (POSITIVE) BATTERY CABLE FROM BATTERY POST.

Hour / Tachometer Reset Instructions:

- 1) Toggle to the appropriate Flash Alert menu to be cleared.
- 2) Press and hold button until "00000" appears. (approx. 3 sec)

Note: Hour glass will flash repeatedly while holding button down during service reset.

General Maintenance (cont.)

RECOMMENDED LUBRICATION

ALL BEARINGS:	GREASE: MOBILITH AW-2 (NLGI grade #2)
DRIVE CHAIN:	DRY LUBRICANT (EG: DRY GRAPHITE)
BLOWER:	OIL: PNEULUBE (Refer to blower manual) GREASE: MOBILITH AW-2 (NLGI grade #2)
ENGINE:	SAE SYNTHETIC MOTOR OIL OIL TYPE: 5W-30 OR 10W-30
AIRLOCK REDUCER:	OIL: KLUBERSYNTH UH1 6-460

Air Intake Shroud

Note: Check air intake shroud periodically to ensure debris isn't getting sucked into engine cooling fan.



Bearing Grease Fittings

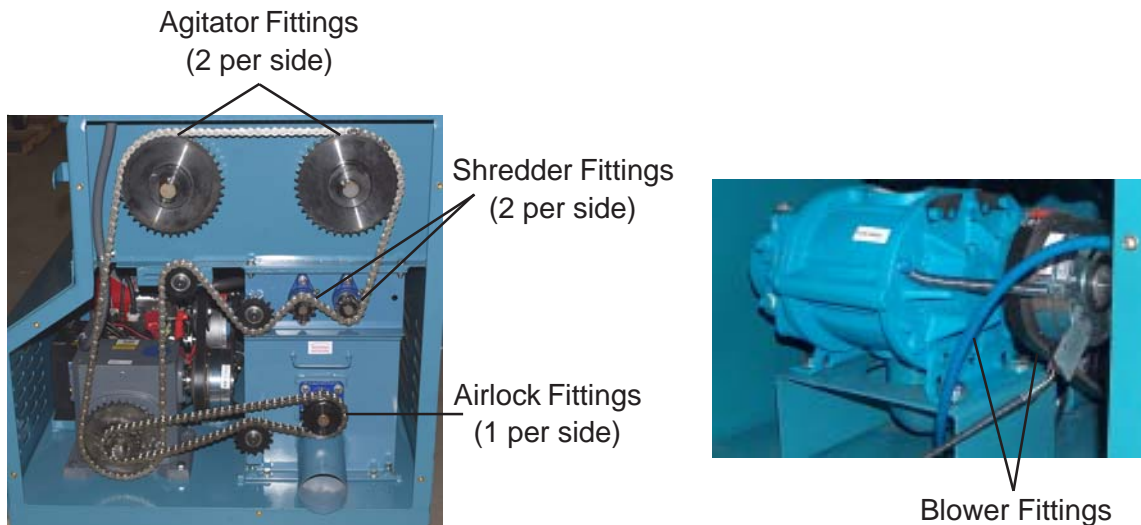

General Maintenance (cont.)

KEEP CLEAN: During operation, keep material from accumulating on Blower Filter. Always keep Filter in place while operating machine. After each use, remove insulation from hopper and blow out hose. (Use BLOWER mode at Main Control Panel or Hand Pendant.) Clean air from insulation hose can then be used to blow insulation from agitator motor and Blower Filter area.

Airlock: (Seal Replacement)

The purpose of the airlock seal is to trap air and insulation until it rotates 180° to the 6:00 o'clock position. At this point, insulation is pushed by air from the blower, out of the chamber. Worn or damaged seals allow air and insulation to escape back into hopper, thus reducing production and coverage. When it is necessary to replace seals, follow these directions:

Remove ignition key and disconnect red positive cable from battery post!! Remove hose from input of airlock, remove chain on output. Using a 5/8" socket, remove hold down bolts from airlock. Lower the front of the airlock down by loosening the jamb nuts and turning the liftbolts counterclockwise. Slide the airlock out of the machine. (See Illustration L) Airlock rotor plates that are damaged (bent) will need replaced. (Refer to Base Plate Replacement on next page.) Take out rubber seal by removing fastening bolts, nuts and top plate. The base plate will remain attached to airlock shaft. To install a new seal, reverse procedure. Seal should be inserted tight against the back base plate, pressing the lower tabs of the seal down under the adjacent seal with a flat blade screwdriver. Make sure all bolt holes are aligned while each side of seal is equally pressed against the end plates, before tightening bolts. Seal should be bent forwards for **counterclockwise** rotation. (See Illustration N on page 21)

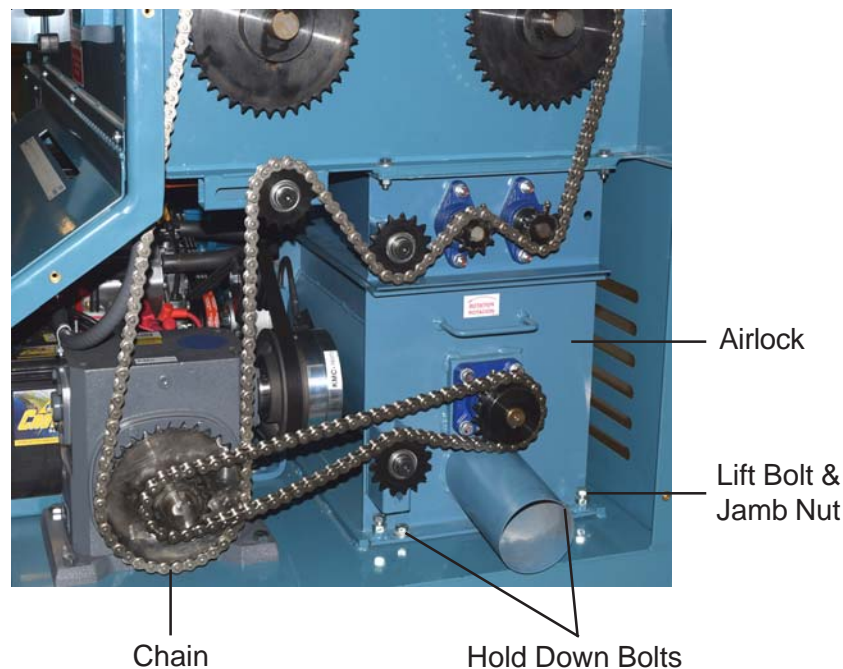

(Illustration L)

General Maintenance (cont.)

BASE PLATE REPLACEMENT:

1. Remove damaged baseplate assembly from shaft using ratchet drive wrench with extension and 1/2" socket.
 2. Check seal for wear and damage. (Installing seal and top plate on the bench is quick and easy). Remove bolts from plate assembly and replace with new seal. Make sure seal and top plate are assembled on **correct** side of base plate before assembling in airlock. Seal should press backward towards top plate when installed correctly into airlock chamber. (Illustration N)
 3. Install the rotor plate assembly into the airlock. The airlock runs **counterclockwise** viewing it from the sprocket drive shaft. (Illustration N) Align the base plate with holes on airlock shaft using a tapered punch. **Caution:** Do not mount rotor plate backwards. If installed improperly, damage to seals will result and put undue stress on agitator motor. This causes overheating and poor production. Seal should be bent forwards to allow for a **counterclockwise** rotation of rotor.
 4. As rotor plate is installed, press bottom tab of seal under adjacent seal with flat blade screwdriver. (See Illustration N)
- Note: Entire rotor plate assembly may be removed and replaced. This procedure maybe easier than replacing just the seals.**

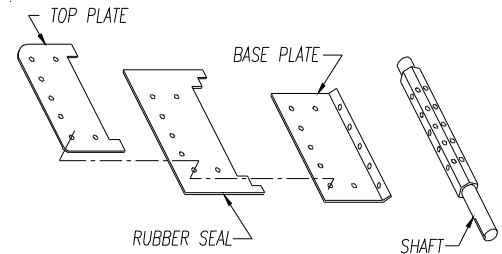

(Illustration M)

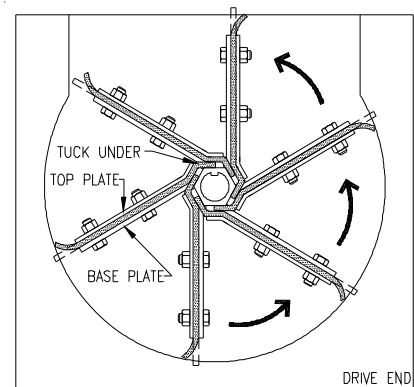

(Illustration N)

CHAIN: (#50 Nickel Plated)

ADJUSTMENT: A smooth operating chain drive should have a slight sag on the idler side of the chain. New chains should be installed under slight tension as they will elongate a small amount due to seating of pins and bushings during the first few days of operation. Chain should be kept in good condition by proper lubrication (dry film lubricant Dow 321) and occasional cleaning. Soaking chain in container of 10 weight oil will provide for internal lubrication of pins and bushings. However, excess oil must be drained and wiped away as excessive lubrication will cause insulation accumulation on chain. Worn out chain should be replaced. When chain is replaced, worn sprockets should also be replaced, preventing further damage to new chain.

SPROCKETS:

CHECK SPROCKETS FOR WEAR. Misalignment and/or loose sprockets and improper chain tension causes the premature wear of chain and sprockets. All sprockets, except speed reducer and idler sprockets, have been secured with a medium grade Loctite (general purpose thread locker), to prevent gradual movement. The set screws and key are also inserted with a medium grade Loctite. If sprocket is difficult to remove, it may be heated with a propane torch to loosen.



Caution: Do not overheat sprocket or damage to bearing will result. A pulley or bearing puller can then be used to remove the sprocket and key. Replace new sprocket on shaft with key and medium grade Loctite applied to shaft. Align sprocket with corresponding sprocket, using a straightedge placed along face of teeth and tighten set screw. Speed reducer sprocket does **not** require Loctite.

General Maintenance (cont.)

BEARINGS:

BEARING REPLACEMENT: Spray area with rust penetrant (WD-40). Remove sprocket (See SPROCKET section on page 21). Remove four bolts from airlock bearing flange (two bolts from shredder bearing flange) Loosen set screws on bearing hub at each end of agitator shaft. Since all set screws are installed with a medium grade Loctite, a propane hand torch may be used to assist in removing them. Do not overheat unit, causing shaft to expand. Using a rubber mallet, drive agitator shaft an inch in one direction, creating a space between hopper and bearing unit. A bearing puller can then be used to remove the bearing. Eliminate any metal burrs from shaft with file and install new bearings with felt seals. Use a medium grade Loctite on set screws before securing bearing to shaft. (Check shaft diameter before ordering bearings; 3/4", 1" or 1 1/4")

AGITATOR, AIRLOCK AND SHREDDER BEARINGS are prelubricated, double sealed, self aligning ball bearings. Lubrication is required at three month intervals of normal running time, or sooner if bearings produce a noise or become too-hot-to-touch. Relubrication at the grease fittings is done with a lithium base grease conforming to a NLGI GRADE TWO consistency. The grease should be pumped in slowly until a slight bead forms around the seals. This bead, in addition to acting as an indicator of adequate lubrication, provides additional protection against the entry of foreign matter. **Important:** If a slight bead does **not** form indicating a failure of lubrication or if bearing shows signs of wear, replace bearing.

SPEED REDUCER:

Periodically check oil level in reducer. Do not lay machine on its side as lubricant from unit will drain from vent plug. If speed reducer malfunctions because of improper oil level or type used, **warranty is voided**. Oil seals at input and output drives are considered to be replaceable maintenance items and can affect oil level. These are available at power transmission distributors. Your speed reducer has been filled with a synthetic lubricant (Klubersynth UH1 6-460). Consult speed reducer manufacturer's manual for lubricant replacement intervals.

LUBRICATION: This speed reducer was filled with oil at the factory to operate within -30°F to +225°F ambient temperature. After 1500 hours of operation, drain and refill with Klubersynth UH1 6-460 gear oil. If Klubersynth UH1 6-460 gear oil is not available, use multipurpose gear oil SAE #90 for ambient temperatures from +40°F to +120°F. For temperatures below +40°F use SAE #80 multipurpose gear oil. Correct oil level for mounted unit is just below pipe plug (D on illustration O) in side position.

LUBRICANT REPLACEMENT: (See Illustration O)

1. Drain: With input shaft of speed reducer facing you, remove plug (A) with 1/4" hex key wrench. Allow unit to completely drain and replace plug.
2. Remove vent plug (B), fill plug (C) and overflow plug (D).
3. Fill with recommended lubricant (use Klubersynth UH1 6-460 gear oil) through fill plug (C) opening, using a flexible funnel, until lubricant exits the side opening (D). (Make sure speed reducer is level when replacing lubricant.)
4. Replace vent plug (B), fill plug (C) and overflow plug (D).

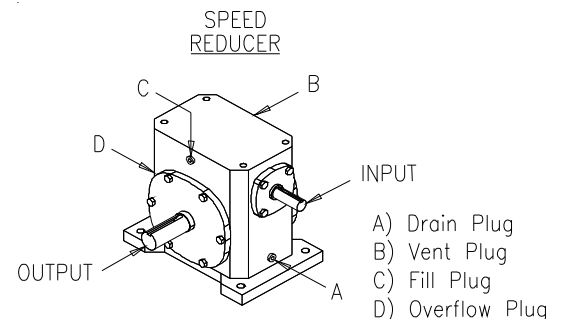

(Illustration O)

ELECTRICAL

ELECTRICAL DIAGRAM:

Periodically check all electrical connections and components for broken or loose wires. **Note: Remove ignition key and disconnect red positive cable from battery post before checking electrical connections.**

WIRE COLOR CODE

G	= GREEN	- Earth Ground
BK	= BLACK	- Neutral (12 volt DC)
R	= RED	- Hot (12 volt DC)

**MODEL #2800-G
12 V.D.C. (U.S.)
(Illustration P)**

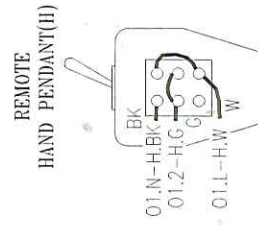

**4-POSITION SELECTOR SWITCH(4S)
CONTACT ACTION**

	BOTTOM LEFT	TOP LEFT	TOP RIGHT	BOTTOM RIGHT
REMOTE	1-1-2	1-1-2	1-1-2	1-1-2
OFF	1-1-2	1-1-2	1-1-2	1-1-2
BLOWER	1-1-2	1-1-2	1-1-2	1-1-2
BLOWER/AGITATOR	1-1-2	1-1-2	1-1-2	1-1-2

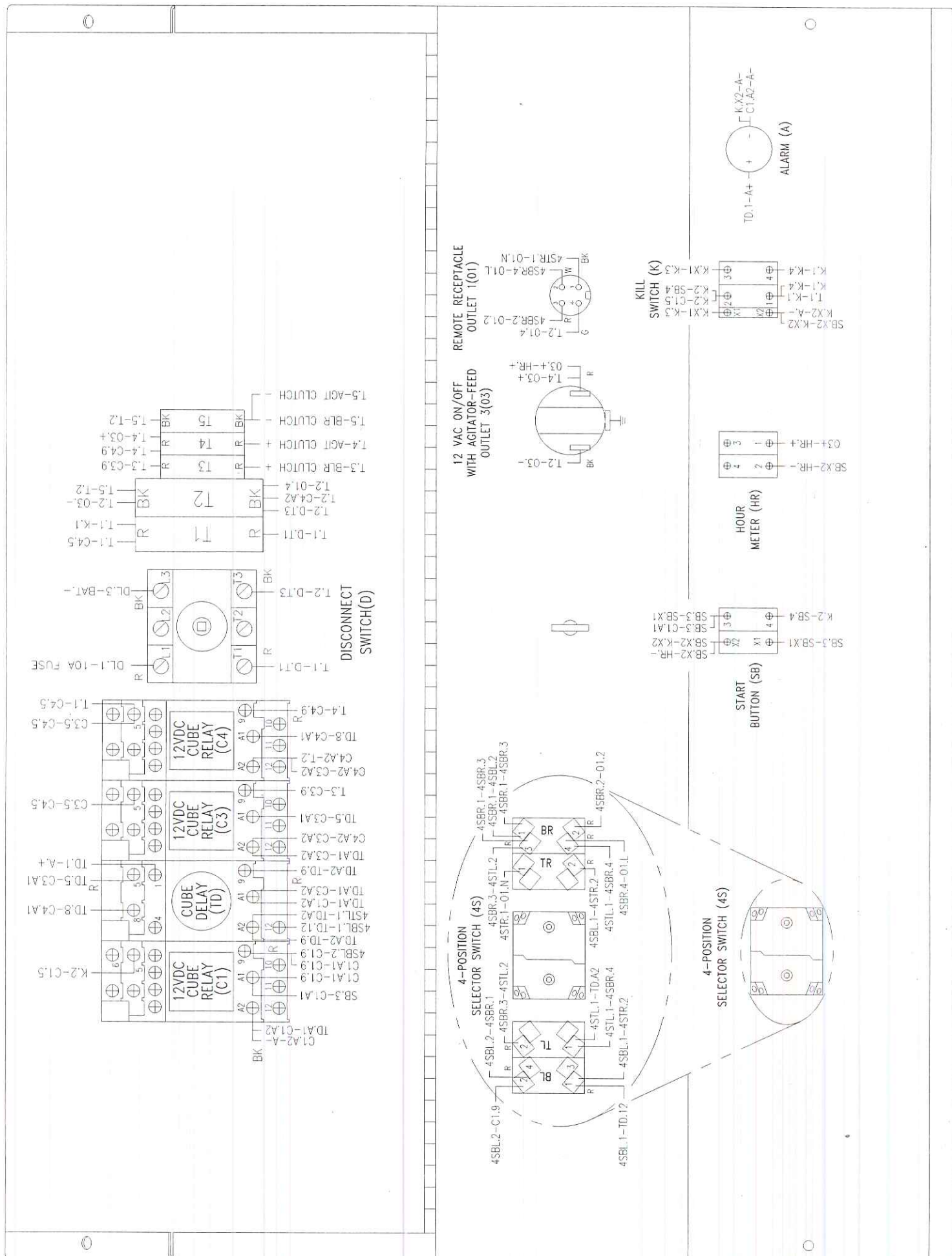

ELECTRICAL DIAGRAM:

Periodically check all electrical connections and components for broken or loose wires. **Note: Remove ignition key and disconnect red positive cable from battery post before checking electrical connections.**

WIRE COLOR CODE

G/⏏ = GREEN/YELLOW - Earth Ground
 GR = GREY - Neutral (12 volt DC)
 BR = BROWN - Hot (12 volt DC)

**MODEL #2800-G
 12 V.D.C. (Overseas)
 (Illustration Q)**

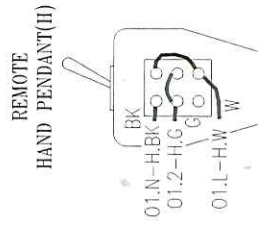

**4-POSITION SELECTOR SWITCH(4S)
 CONTACT ACTION**

REMOTE	1-1-2	1-1-2	1-1-2	1-1-2
OFF	1-1-2	1-1-2	1-1-2	1-1-2
BLOWER	1-1-2	1-1-2	1-1-2	1-1-2
BLOWER/ AGITATOR	1-1-2	1-1-2	1-1-2	1-1-2
	BOTTOM	TOP	TOP	BOTTOM
		LEFT	RIGHT	

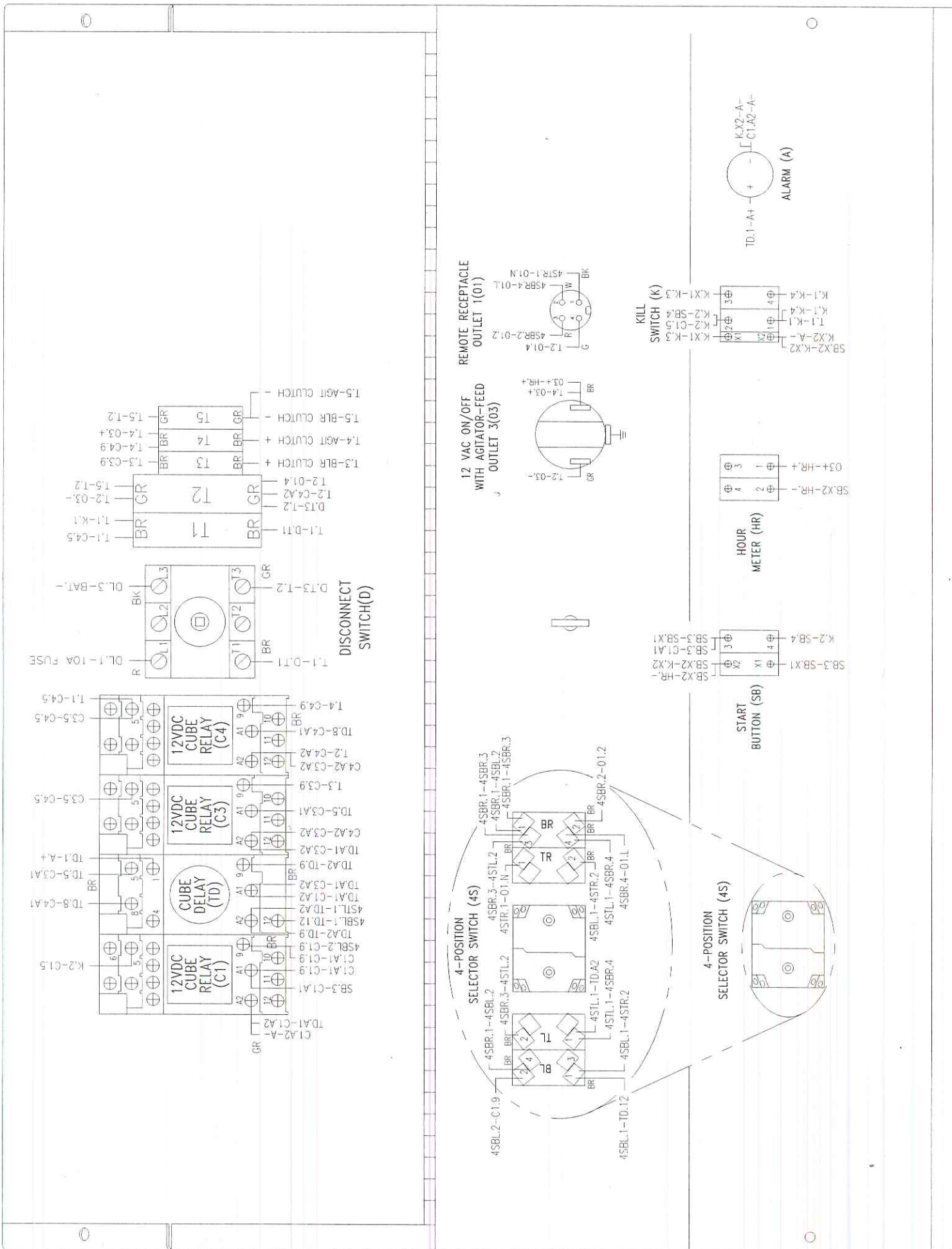

ELECTRICAL SYSTEM**ELECTRICAL DIAGRAM:**

Periodically check all electrical connections and components for broken or loose wires, loose screws or fasteners. Machine Vibration can cause fasteners to loosen. **Note: Remove ignition key and disconnect red positive cable from battery post before checking electrical connections.**

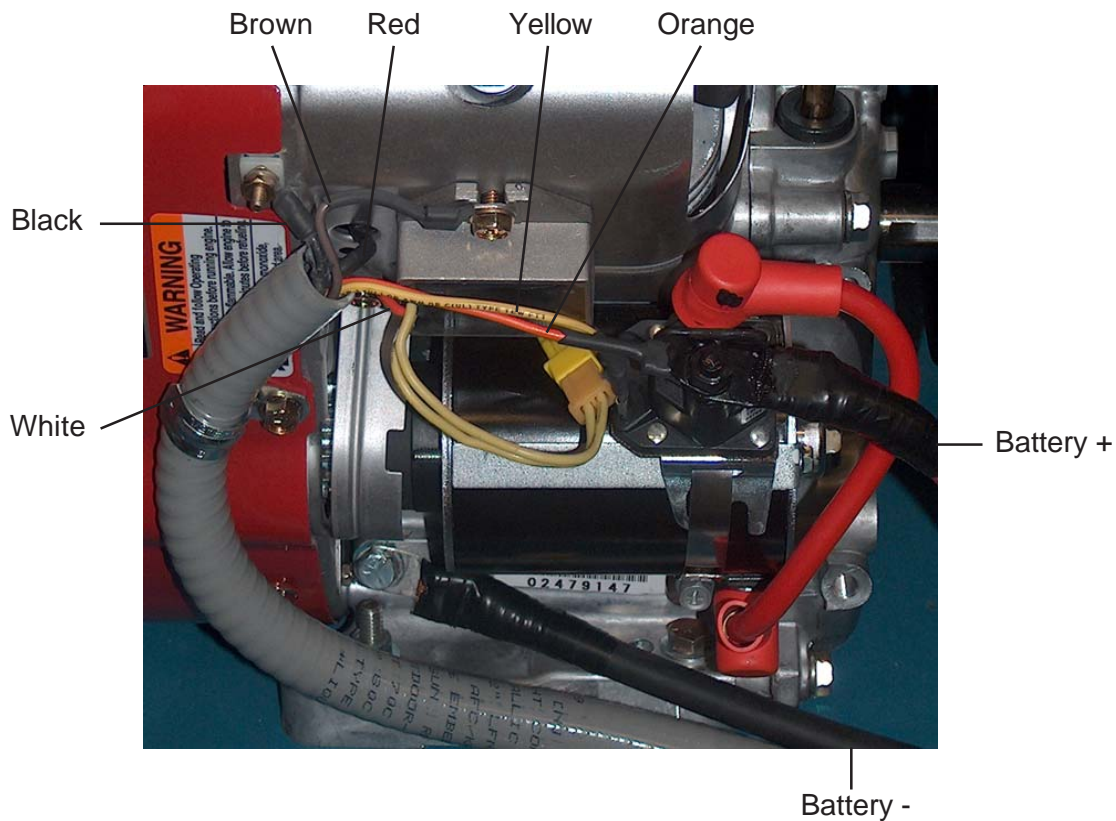
**MODEL #2800-G
IGNITION TO MOTOR****Illustration R**

TROUBLESHOOTING**WARRANTY**

This unit is backed by a warranty for manufacturer's defects. If machine needs service during that time, call your supplier immediately. **Do not** attempt to service, as this voids warranty.

IMPORTANT

At any signs of trouble with your machine, stop immediately, turn ignition key off and call your supplier. Refer to *General Maintenance* section of this manual for further details. Always turn machine off, remove ignition key and disconnect red cable from battery post before making inspection or repairs.

TROUBLESHOOTING**Problem****Corrective Action**

- | | |
|--|---|
| 1) Engine will not start | A. Check if battery charge is low.
B. Check terminals on battery for good connection.
C. See Engine Manufacturer's Manual. |
| 2) Engine starts but there are no other machine functions - no electrical power to the front panel | A. Check for loose or damaged wires, ground shorts which may be caused from machine vibration.
B. Turn off all power to machine before opening the panel box.
C. Check Kill Switch. |
| 3) Engine starts - but the blower will not operate | A. Check to see if the blower clutch is operating.
B. Check clutch electrical connections.
C. Check belts, adjust or replace as required.
D. Check battery, clutch will not cycle or will slip if battery is not fully charged.
E. Check that blower can be turned by hand. If not, blower may be tied up.
F. Weak/Worn clutch - replace or rebuild as required. |
| 4) Insufficient air - clutch is operating | A. Check that the blower control valve isn't fully open. Close or adjust the handle control as needed. You should be able to get over 4 p.s.i. of air on gauge. (See Illustration S)
B. Check that the blower relief valve is not stuck open. (See Illustration T on page 28)
C. Check if blower air filter and intake hose is clogged.
D. Check airstream and bypass air hose connections, clamps, etc. |

Blower Control Valve

**(Illustration S)**

Troubleshooting (cont.)



Relief Valve
Air Check Valve
(Illustration T)

5.) No material flow - clutch is operating

- E. Check that the one way air check valve isn't stuck closed. (See Illustration T)
 - F. Check belts, adjust /replace as required and check for missing keys under drive pulleys.
 - G. Insulation hose plugged. Make sure the air bypass valve is completely closed, then switch machine to blower only to blow out the hose. If problems still occur, try hitting the hose where it is plugged to release the material.
 - H. If the airlock seals and/or airlock components are worn or damaged, replace all the parts as needed.
-
- A. Check material level in main hopper.
 - B. If the material slide gate is closed or adjusted in too far for material feed rate, open the slidegate.
 - C. Check the belts coming from the main drive shaft pulley to the reducer shaft drive pulley and blower drive pulley. Adjust or replace belts as required. Check for missing keys under the drive pulleys.
 - D. Check chains, adjust or replace as required. Check for missing keys under drive sprockets.
 - E. Insulation hose plugged. Make sure the air bypass valve is completely closed, then switch machine to blower only to blow out the hose. If problems still occur, try hitting the hose where it is plugged to release material.

SPARE PARTS LIST

The following is a recommended spare parts list. To keep your machine up and running, these are the parts we suggest you keep on hand for your Model #2800-G Krendl Machine.

PART NUMBER	DESCRIPTION	QUANTITY REQUIRED
250503-8	AGITATOR BEARINGS	4
250503-7	AGITATOR BEARING FELT SEALS	4
426-6	SHREDDER BEARINGS	4
426-7	SHREDDER BEARING FELT SEALS	4
517-6	AIRLOCK BEARINGS	2
517-7	AIRLOCK BEARING FELT SEALS	2
28-51	V-BELT ENGINE TO GEAR BOX	1
28-52	V-BELT ENGINE TO BLOWER	1
209031-8M-2PLYF	AIRLOCK SEALS	6
150526	#50 MASTER LINK	3
81-1063	BLOWER FILTER	1
2800MK	2800-G MAINTENANCE KIT	1

PARTS LIST

MODEL #2800-G EXPLODED PARTS VIEW

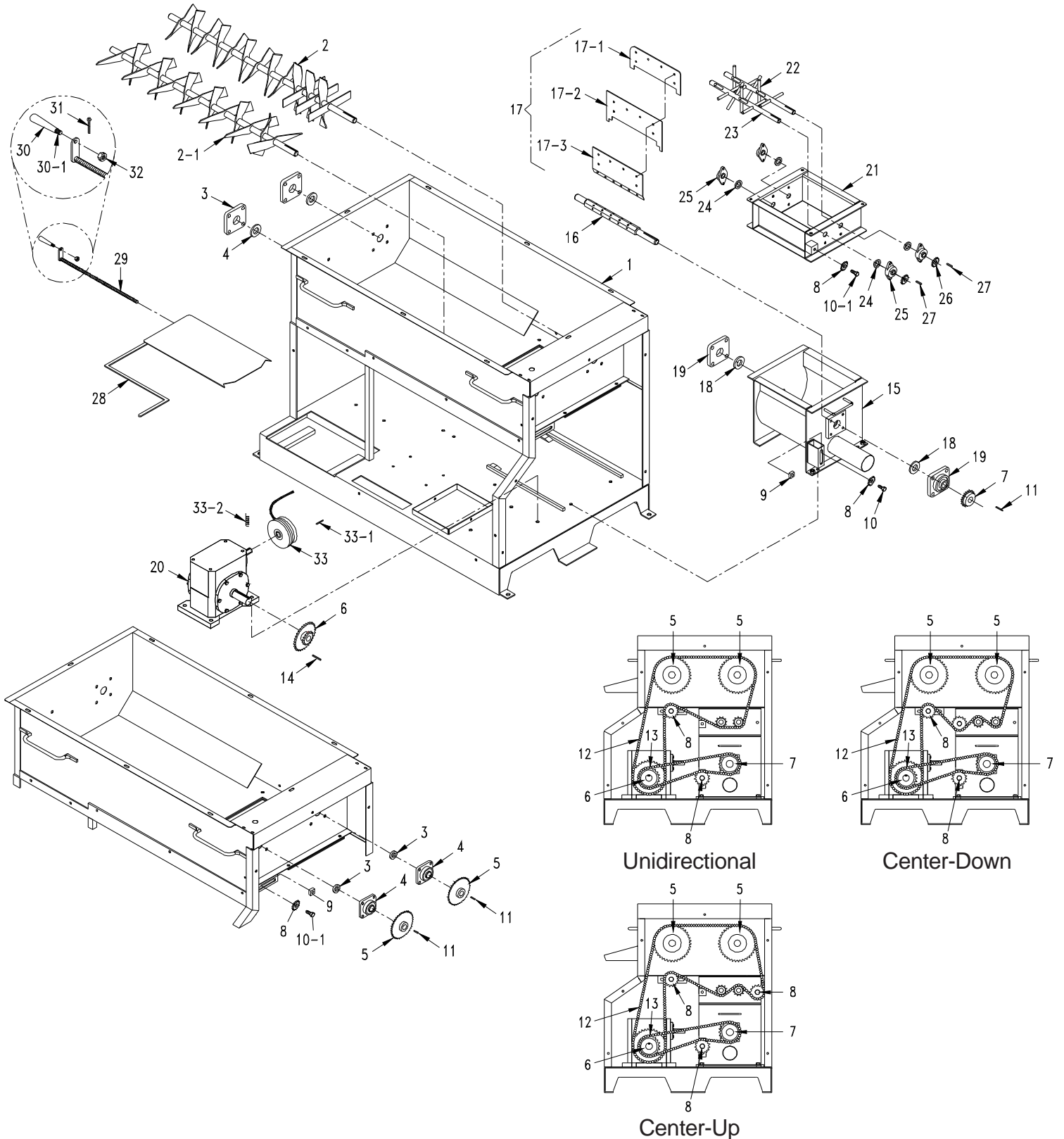

MODEL #2800-G EXPLODED PARTS VIEW

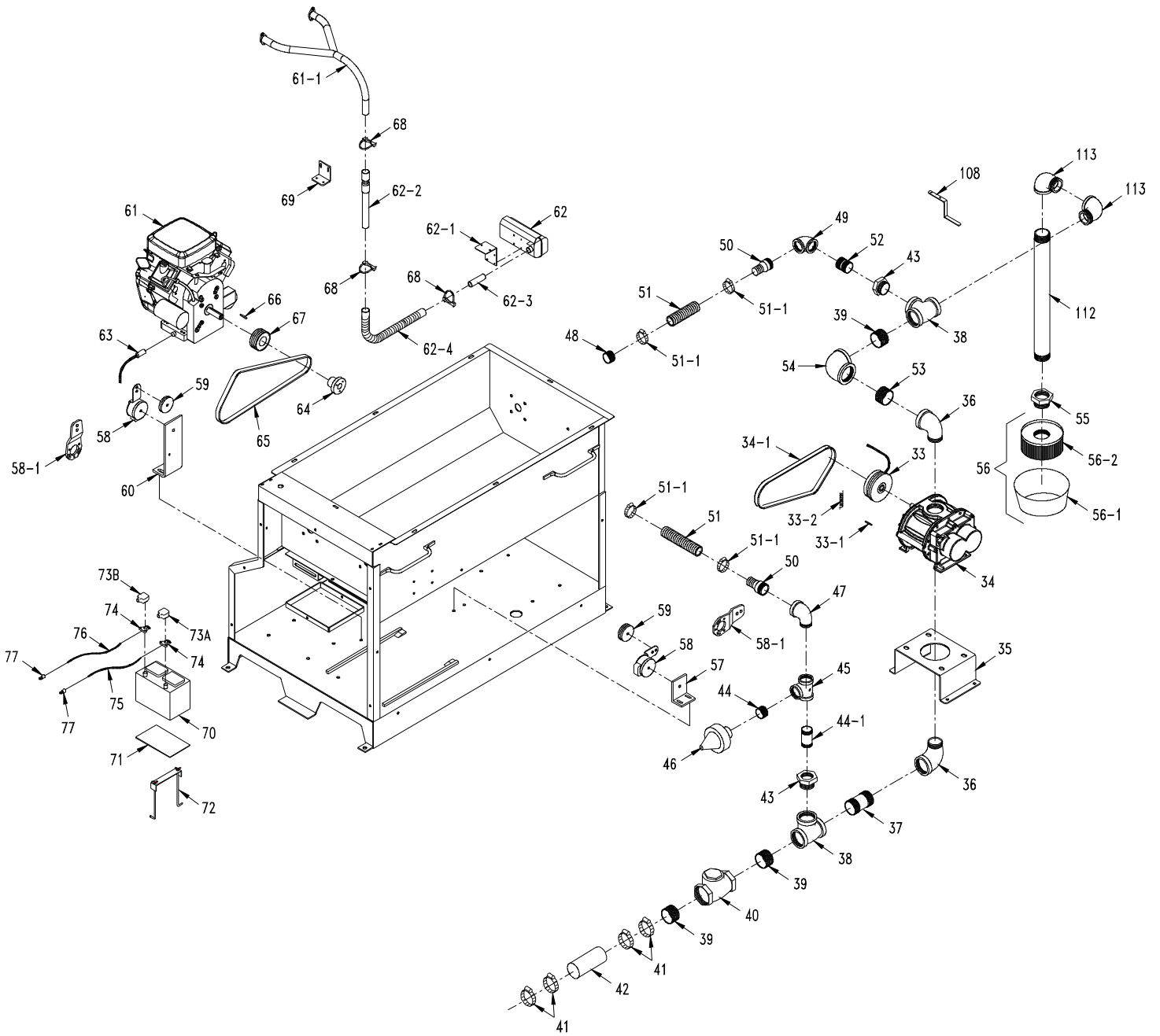

MODEL #2800-G EXPLODED PARTS LIST

Item #	Part #	Description
1	28-1-R1	Base, Complete
2	13-9	Agitator, Shredder, 1 1/4"
2-1	13-8	Agitator, Hopper, 1 1/4"
3	250503-8	Bearing, 1 1/4", 4-Bolt Flange (4)
4	250503-7	Seal, Felt, 1 1/4" (4)
5	5200-42	#50 Sprocket, 40T x 1 1/4" Bore (2)
6	28-11	#50 Sprocket, 35T x 15T x 1 3/8" Bore
7	8148	#50 Sprocket, 18T x 1" Bore
8	150513	#50 Sprocket, Idler, 15T x 5/8" (3)
9	40052	Nut, 1" x 1" x 1/2", Plated (2)
10	FSB120	Shoulder Bolt, 5/8" x 3/4"
10-1	FSB092	Shoulder Bolt, 5/8" x 1" (2)
11	562Z	Key, 1/4" x 1/4" x 1 1/4" (3)
12	50NP-103	Chain, #50 x 103" (Uni-directional)
12	50NP-2	Chain, #50 x 2" (Uni-directional to Center-Down) (Uni-directional to Center-Up)
13	200500-8	Chain, #50 x 46" (Airlock)
14	260582	Key, 5/16" x 5/16" x 2"
15	23-1-R5	Airlock, 3" in, 4" out
16	23-2	Shaft, Airlock
17	209031-8-ASSY	Seal Assembly, (2 PLY/FAB) 16"
17-1	209031-9	Top Plate, 16"
17-2	209031-8M-2PLYF	Seal, Airlock (2 PLY/FAB) 16"
17-3	209031-7	Base Plate, 16"
18	517-7	Seal, Felt 1" Airlock (2)
19	517-6	Bearing, 1", 4-Bolt Flange (2)
20	28-53	Gear Box R-Angle 30:1
21	23-4	Shredder Box
22	23-6	Shredder Agitator, 10 Tine, Short
23	23-5	Shredder Agitator, 9 Tine, Long
24	426-7	Felt Seal, 3/4", Shredder Box (4)
25	426-6	Bearing, 3/4", 2-Bolt Flange (4)
26	S-50BS10	#50 Sprocket, 10T x 3/4" Bore (2)
27	448Z	Key, 3/16" x 3/16" x 1" (2)
28	28-3	Slidegate
29	23-8	Slidegate Crankrod
30	1300-9	Handle
30-1	1300-9-1	Mounting Rod, Slidegate Handle
31	FSB078	Cotter Pin, 1/8" x 1"
32	FN015	3/8-16 Lock Nut, Crimped
33	5200-101	Clutch, Shaft Mount, 2 Groove (2)
33-1	1556	Key, 3/16" x 3/16" x 1 1/4" (2)
33-2	5200-114	Spring, 9/16 x 6 x .072 (2)
34	2100-2	Blower, P.D.
34-1	28-52	V-Belt 2 Groove 50" Long
35	28-5	Blower Mount
36	8054	Elbow, 90 Degree, 2 1/2" Street (2)
37	8046	Nipple, Pipe, 2 1/2" x 5" Long

MODEL #2800-G EXPLODED PARTS LIST

Item #	Part #	Description
38	8045	Tee, 2 1/2" (2)
39	8067X	Nipple, Pipe, 2 1/2" (3)
40	8068	Check Valve, 2 1/2"
41	339A	Clamp, Hose, 3" (4)
42	2801	Hose, Radiator, 3", 8 1/2" Long
43	250300-12-2X	Bushing Reducer, 2 1/2" - 2"
44	5200-81-1	Nipple, 2" Close Black Pipe
44-1	28-35	Nipple, Galvanized, 2", 4" Long
45	4000-43	2" Tee W/Pressure Relief
46	4200-12	Relief Valve 6 P.S.I.
47	5200-56-6	Elbow, 2" 90 Degree Street
48	57801	Nipple, 1 1/2" Close Black Pipe (2)
49	109612	Elbow, 90 Degree, 2"
50	5200-81X	Adapter, 2" Barb (2)
51	RM-OTH085-MI	Hose, Radiator, 2"
51-1	337	Clamp, Hose, 2" (4)
52	250338-3	Nipple, Pipe, 2" x 3" Long
53	8030-1-5X	Nipple, Pipe, 2 1/2" x 3" Long
54	8044	Elbow, 90 Degree, 2 1/2"
55	2100-10	Bushing, 3" to 2 1/2"
56	250300-2-R1	Silencer, Filter Intake (Blue)
56-1	--	Cover, Filter
56-2	81-1063	Filter f/250300-2-R1 (Blue)
57	5200-105-R1	Bracket, Pulley Mounting
58	5200-22	Tensioner, H.D., Rotary (2)
58-1	GV230-33	Tensioner Arm (2)
59	5200-96	Idler, 2GR3V3.35 (2)
60	28-7	Tensioner Bracket
61	4000-22	Engine, 18HP
61-1	28-17	Manifold, Y-Tube
62	28-34	Muffler
62-1	28-27	Bracket, Mounting, Muffler
62-2	28-18	Exhaust Adapter
62-3	28-28	Muffler Connector Tube
62-4	4000-42	Pipe, Exhaust, 1 1/8" Flex, 24" Long
63	4000-27/28	Drain Valve, Hose & Cap Kit
64	4000-21	Bushing
65	28-51	V-Belt 2 Groove 60" Long
66	150311Z	Key, 1/4" x 1/4" x 1 3/4"
67	28-54	Sheave 4 Groove 3.65OD
68	4000-41	U Clamp, 1 1/4" Muffler (3)
69	28-19	Bracket, Support, Manifold
70	5200-75	Battery
71	28-26	Battery Pad, Rubber
72	5200-79-R	Bracket, Battery Hold Down
73A	4000-50	Cover, Battery Terminal, Red
73B	4000-51	Cover, Battery Terminal, Blk
74	ST301-3	Connector, Battery Terminal (2)

MODEL #2800-G EXPLODED PARTS LIST

Item #	Part #	Description
75	RM-OTH002-RD	Wire, 2 Ga Red, 10" long
76	RM-OTH002-BK	Wire, 2 Ga Black, 18" Long
77	ST301-4	Connector, Wire, Battery, Copper (2)
78	2800G-KT-ELU-R1	Electrical Box Assembly (U.S.)
78	2800G-KT-ELU-OS-R1	Electrical Box Assembly (Overseas)
79	RC395-K	Remote Control Cord Assembly, 4 Pin Connector 150 Ft.
80	18-4 SJ	Wire, #18-4 (SJ) x 150 Ft.
81	487	Connector, 4 Pin Male
82	RC395-DPDT	RC Service Kit (DPDT)
82-1	RC395-1	Switch Housing, Remote Control
82-2	RC395-2	Switch Back Plate, Remote Control
82-3	1536-4	Strain Relief
82-4	109066-9	Switch, Toggle (DPDT)
82-5	1536-7	Belt Clip
82-6	KMC-087	Decal, Feed Blower (Not Shown)
82-7	RC395-4	8-16 Plastite Screw (4) (Not Shown)
83	1300-1-R3	Hopper Extension
84	23-99	Latch, Pull (2)
85	28-14-R1	Side Guard
86	28-8P-R3	Front Guard
87	28-4	Motor Guard
87-1	KS342	Motor Guard Latch and Keeper
88	28-9-R1	Rear Guard
88-1	HZ-1001-8	8" Cooling Fan
89	28-13-R1	Motor Intake Shroud
89-1	28-25-R1	Air Vent Shroud
90	28-15	Canopy
91	28-6	Control Panel
92	28-12	Fuel Tank Guard
93	4000-24	Choke Control
94	260301-7	Pressure Gauge Panel Mount 0-10
95	IWS-32	Male Connector (2)
96	IWS-29	Swivel, SAE 37 (2)
97	IWS-H-1/4	1/4" Hose, 48" Long
98	4000-39	Blower Control Elbow
99	ST250-6-2	Ball Valve, 1 1/2"
100	260500	Pointer Indicator Device
101	GV100-11	Hour Meter
102	28-36	Fuel Tank
102-1	KP1000-46	Fuel Tank Hold Down Straps (2)
102-2	28-57	Filter, Fuel
103	104	Clamp, Spring Pinch (7)
104	RM-OTH202-EPA	1/4" Fuel Line, 22" Long
105	RM-OTH202-EPA	1/4" Fuel Line, 48" Long (2)
106	BS-230	Fuel Shut Off, Inline
107	23001	Barb, 1/4" x 3/16" Splicer, Plastic
108	28-29	Blower Filter Holder
109	H460	Hose, 8" HT, 24" Long
110	4000-38	Clamp, Hose, 8" (2)
111	4000-36	Flange, Engine Fresh Air
112	28-31	Blower Air Input Manifold
113	8054	Elbow, 90 Degree - 2 1/2" Street (2)

**MODEL #2800-G 12 V.D.C.
ELECTRICAL PARTS LIST**

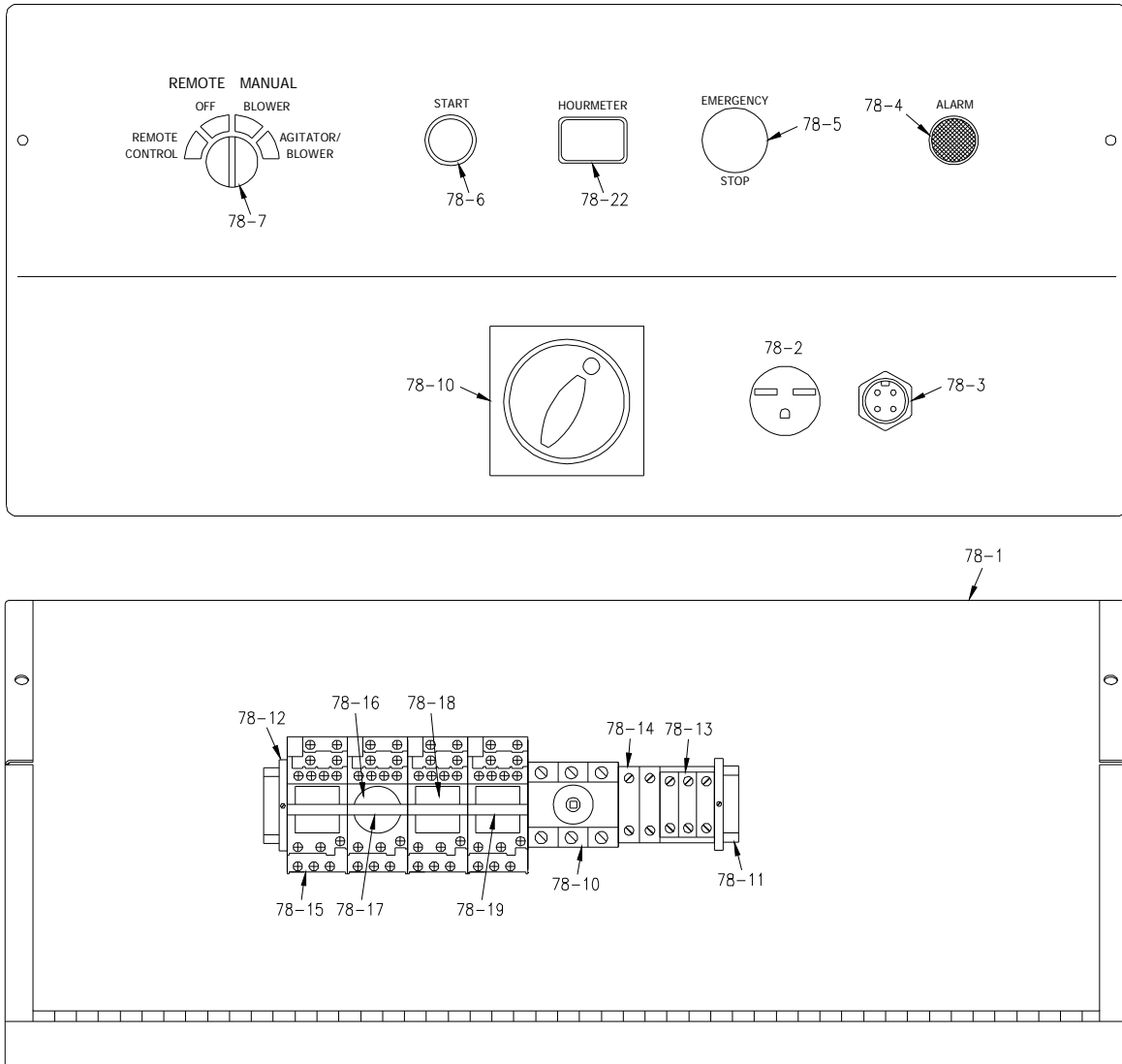

Electrical Exploded Parts List

Item#	Part#	Description	Item#	Part#	Description
78-1	28-10-R2	Box, Electrical	78-10	600-R-01	Disconnect Switch Assembly 3P Red
78-2	132-B	Receptacle, NEMA #6-15R	78-11	ELU12-A	Dinrail, 1 3/8", 16" Long
78-3	491	Connector, 4 Pin Female (remote)	78-12	151080-49	Clamp, f/ 1 3/8" Din Rail (2)
78-4	543-M-38	Alarm for Pre-Alarm System, 24V	78-13	151080-61	Terminal Block, Small (3)
78-5	543-O-04	Switch, Kill, Red	78-14	151080-62	Terminal Block Large (2)
78-5-1	8075-1	Contact Block (not shown)	78-15	4000-32-3	Relay Socket (4)
78-6	543-O-01	Switch, Pushbutton On, Green	78-16	4000-32-7	Relay, Time Delay
78-6-1	543-O-02	Block, Switch, 12 VDC (2) (not shown)	78-17	4000-32-8	Relay Wire Hold Down Clip
78-7	543-M-22	Switch, 4-position Selector	78-18	4000-32-2	12VDC Relay (3)
78-8	543-M-15	Contact Block , Selector Switch (white) #KA-1 (not shown)	78-19	4000-32-4	Relay Plastic Hold Down Clip (3)
78-9	543-M-16	Contact Block , Selector Switch (red) #KA-3 (3) (not shown)	78-20	4000-37	30 Amp Fuse Holder (not shown)
			78-21	4000-37-1	Fuse, Automotive 10 Amp (not shown)
			78-22	543-M-77	Hour Meter

GLOSSARY

BRIDGING	Tendency of insulation to cling in the hopper forming an air pocket above the airlock. This hinders the normal feeding process of the machine.
CFM	(Cubic feet per minute). A measurement of volume or quantity of air flowing at a certain rate, or air moving capability, of a blower. It is the volume of air moved per minute. Higher volume provides increased coverage and velocity of insulation as it leaves the hose.
CHECK VALVE	An apparatus that allows air to flow in one direction only. When mounted on the outlet of the blower, it protects the blower from insulation contamination through the air hose when using one blower. When the blower stops, the valve closes.
COMMERCIAL SPRAY ON	The application of insulation with adhesive to a surface which will remain exposed. The application must therefore be impacted in a smooth, uniform manner.
COVERAGE	Refers to the amount of insulation coverage, usually measured in square feet, according to the R-value desired. This information is given on the insulation package.
NEW CONSTRUCTION WALL CAVITY SPRAY	The spray application of insulation with water or adhesive into an exposed wall cavity to later be covered with drywall sheathing, etc.
PSI	(Pounds of pressure per square inch). The force exerted on a surface by air/liquid. High-pressure blowers push the insulation through the hose. Higher pressure provides less hose plugging and increased compaction in side wall.
PRODUCTION RATE	Pounds of insulation blown per hour.
RPM	(Revolutions per minute). Speed at which the shaft of a rotating device (i.e. blower fan, agitator) is moving.
R-VALUE	Resistance value. A precise measurement of the insulation's resistance to heat transfer. The higher the resistance value, the slower the heat will transfer through the insulating material.
RETRO-SIDEWALL	This refers to the installation of insulation into an unexposed wall cavity. Insulation is usually installed through holes drilled into the exterior siding.
SETTLED DENSITY	The point at which the insulation will not continue to settle further. Any insulation blown will have a certain amount of progressive settling that occurs after a period of time. Following the insulation manufacturers recommendations for bag rate coverage will provide useful information to accommodate for settling.
SETTLING	Compression or compaction of insulation fibers caused by the weight of the material, vibration of structure, temperature, and humidity cycles.

SERVICE RECORD

DATE	MAINTENANCE PERFORMED	COMPONENTS REQUIRED



60 YEARS OF AMERICAN INGENUITY

Made in the U.S.A.

**KRENDL MACHINE COMPANY • 1201 SPENCERVILLE RD
DELPHOS, OHIO 45833 • TELEPHONE 800-459-2069 • FAX 419-695-9301
E - MAIL: krendl@krendlmachine.com • WEB SITE: www.krendlmachine.com**
